



software modeling



- one thing that we as software engineers can do to better understand software is by using models
- many choices when building models
 - multiple modeling “languages”
 - graphical/textual
 - diagrams – ER diagrams for data, class and object diagrams in OOP.
 - ad-hoc
- in this course we’ll study some UML



- uml as defined by wikipedia:

“UML is a standardized general-purpose modeling language in the field of object-oriented software engineering. The UML includes a set of graphic notation techniques to create visual models of object-oriented software-intensive systems.”

- caveat: how often do I use (strict) uml?

“...in his eighteen years as a professional programmer, Wilson had only ever worked with one programmer who actually used it voluntarily .” – Two Solitudes Illustrated, Greg Wilson & Jorge Aranda, 2012

- regardless, software models are very useful



why build models?

- modeling can guide your exploration:
 - can help figure out what questions to ask
 - can help reveal key design decisions
 - can help uncover problems
- modeling can help us check our understanding:
 - reason about the model to understand its consequences
 - does it have the properties we expect?
 - animate the model to help visualize software behavior
- modeling can help us communicate:
 - provides useful abstractions that focus on the point you want to make...
 - ...without overwhelming people with detail
- throw-away modeling
 - making the model is more important than the model itself
 - time spent perfecting models is probably time wasted



maps as abstractions

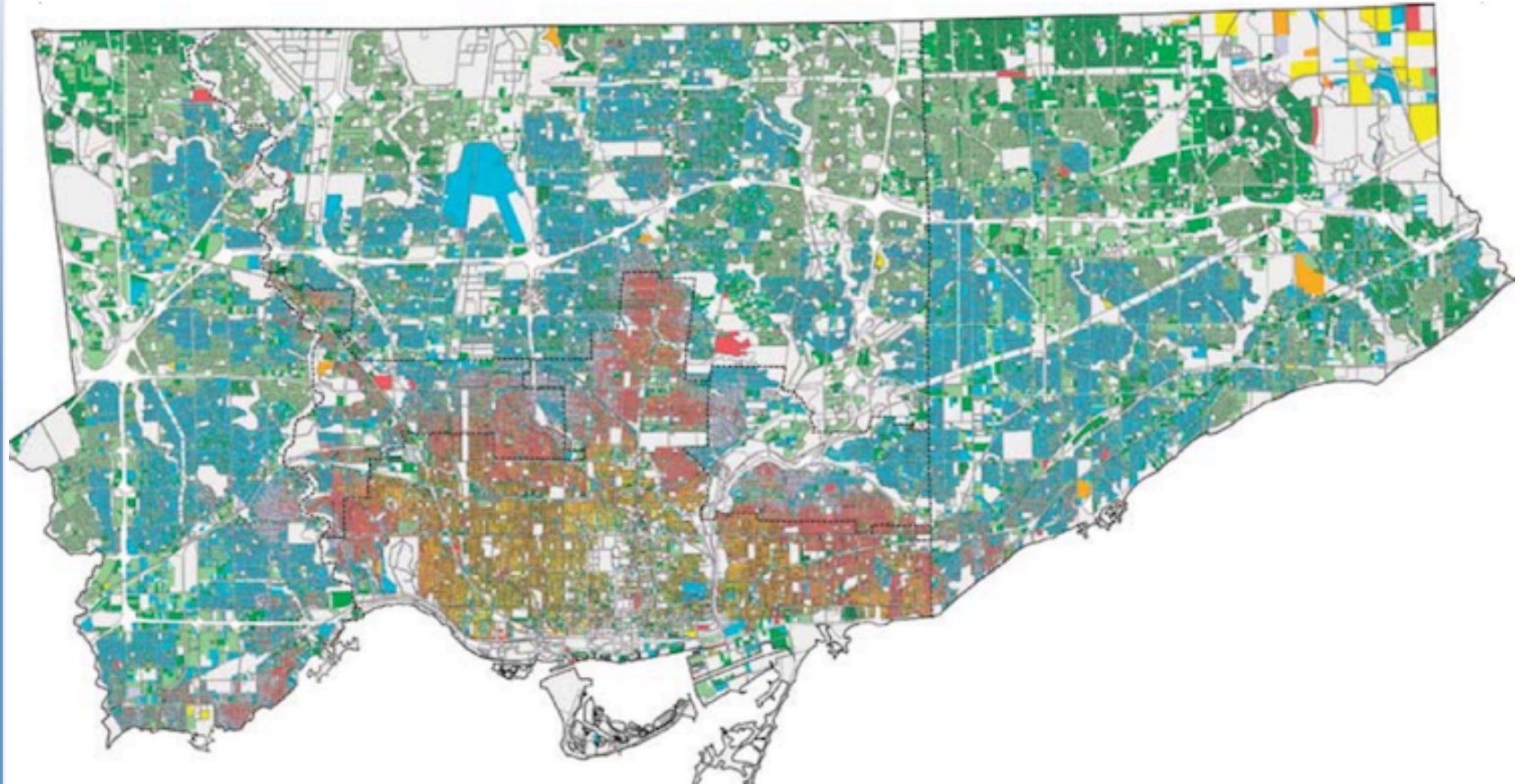



maps as abstractions (2)

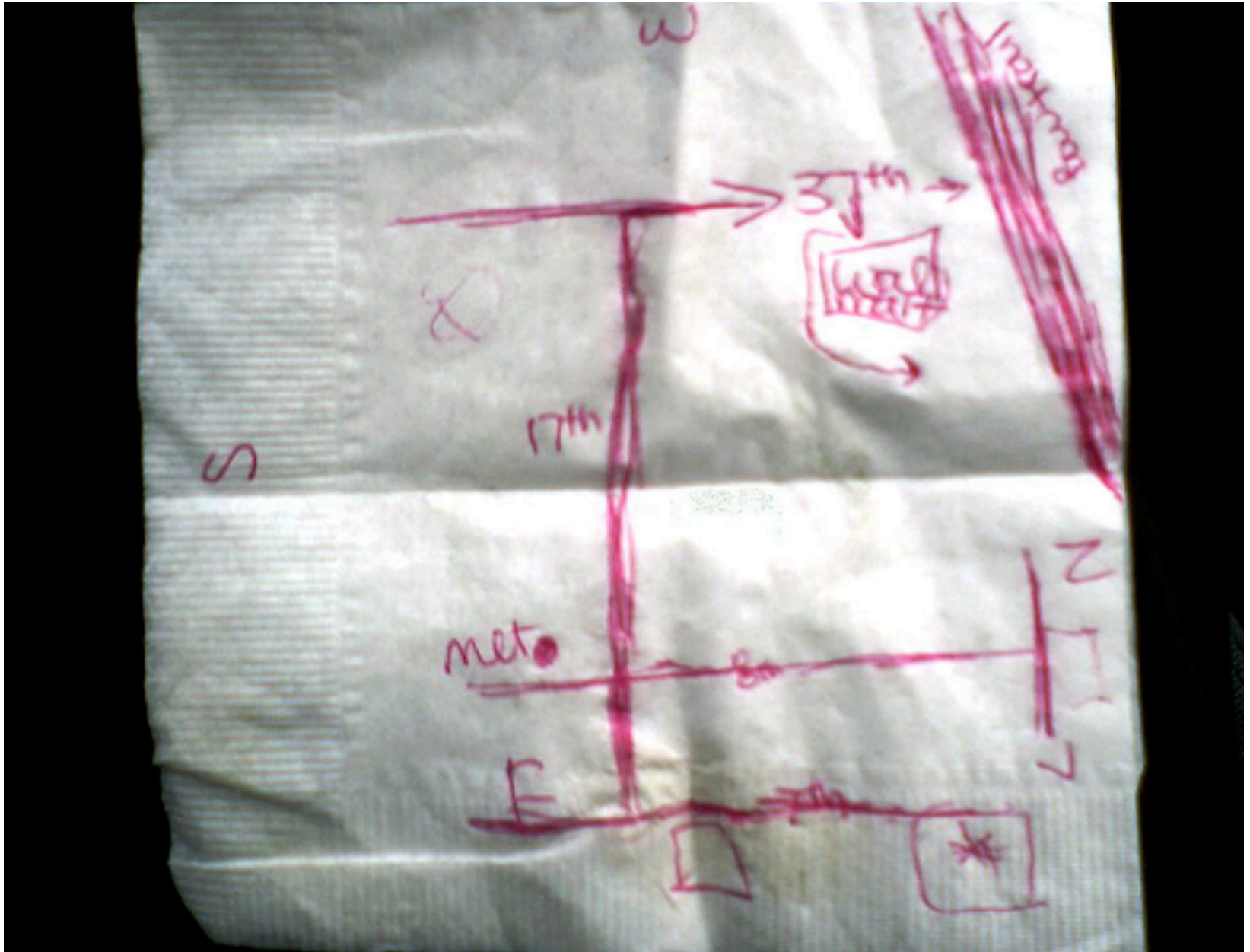



dealing with problem complexity

- abstraction
 - ignore detail to see big picture
 - treat objects as the same by ignoring certain differences
 - (beware: every abstraction involves choice over what is important)
- Decomposition
 - partition a problem into independent pieces to study separately
 - (beware: the parts are rarely independent really)
- Projection
 - separate different concerns (views) and describe them separately
 - different from decomposition – does not partition problem space
 - (beware: different views will be inconsistent most of the time)
- Modularization
 - choose structures that are stable over time, to localize change
 - (beware: any structure makes some changes easier & others harder)



unified modeling language

- third generation OO method
 - Booch, Rumbaugh & Jacobsen are principal authors
 - still evolving (maybe) – version 2.0
 - attempt to standardize proliferation of variants
 - purely a notation
 - no modeling method associated with it
 - intended as design notation
 - has become (more or less) an industry standard
 - primarily promoted by IBM/Rational (who sell lots of UML tools/services)
- Has a standardized meta-model
 - use case diagrams, class diagrams, sequence diagrams, state chart diagrams, activity diagrams, component diagrams, package diagrams, deployment diagrams,...



unified modeling language (2)

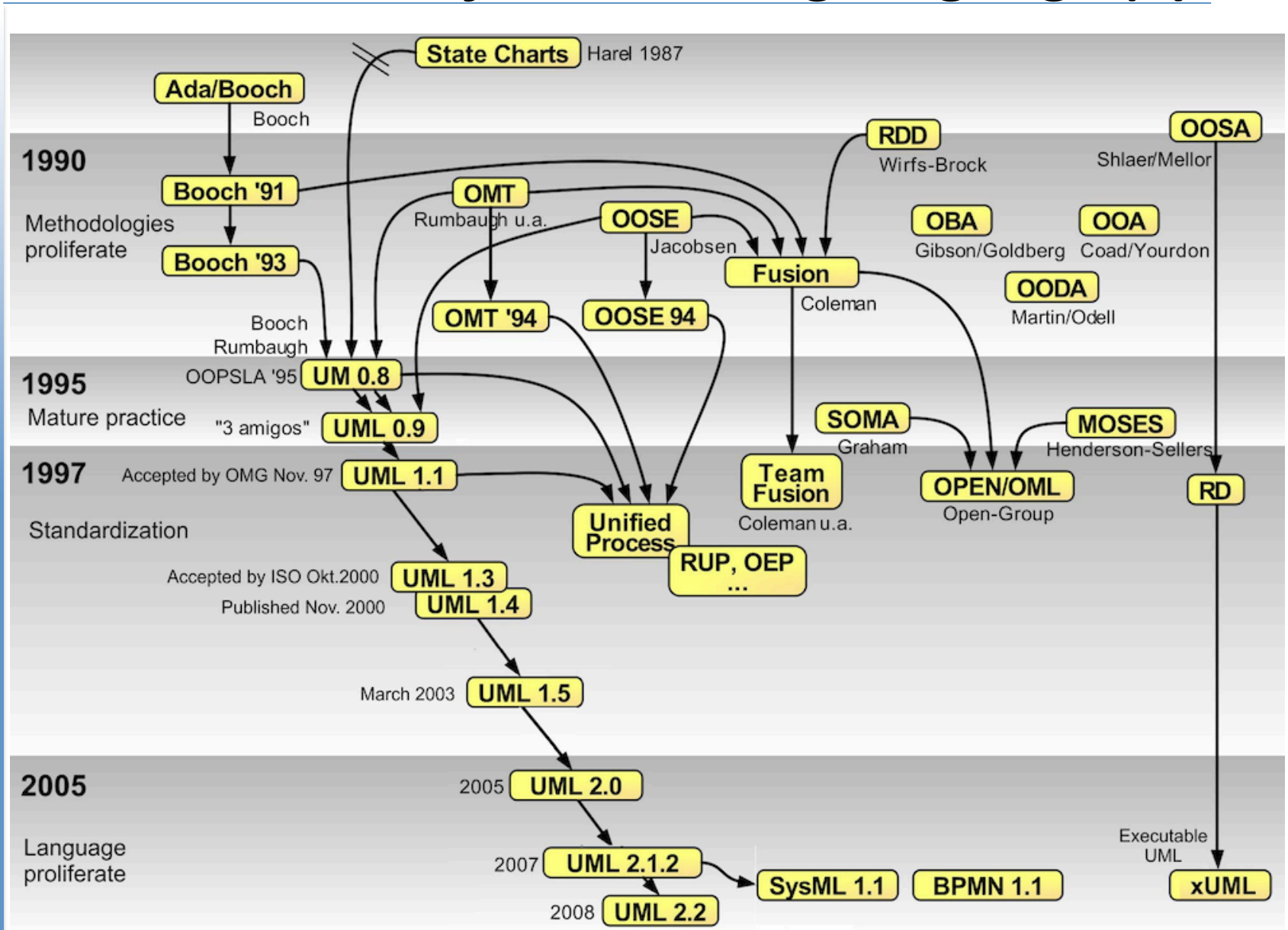

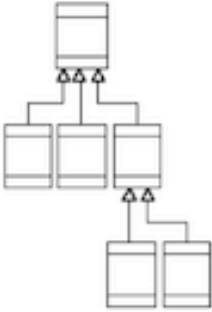
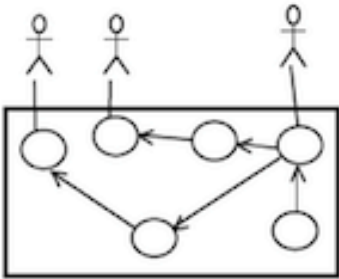
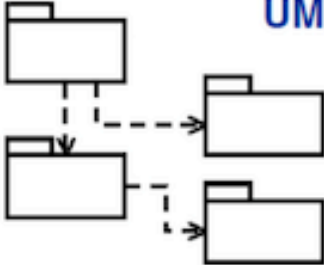
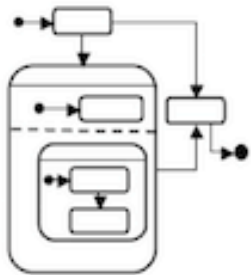
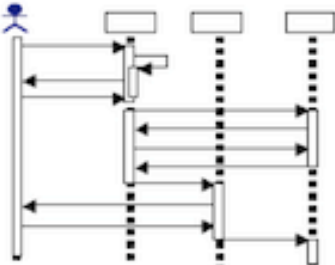
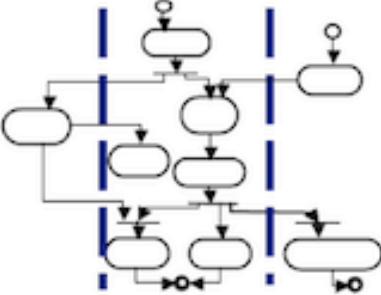

modeling notations

 <p>UML Class Diagrams information structure relationships between data items modular structure for the system</p>	 <p>Use Cases user's view Lists functions visual overview of the main requirements</p>
 <p>UML Package Diagrams Overall architecture Dependencies between components</p>	 <p>(UML) Statecharts responses to events dynamic behavior event ordering, reachability, deadlock, etc</p>
 <p>UML Sequence Diagrams individual scenario interactions between users and system Sequence of messages</p>	 <p>Activity diagrams business processes; concurrency and synchronization; dependencies between tasks;</p>



object classes in uml

Source: Adapted from Davis, 1990, p67-68

Generalization (an abstraction hierarchy)

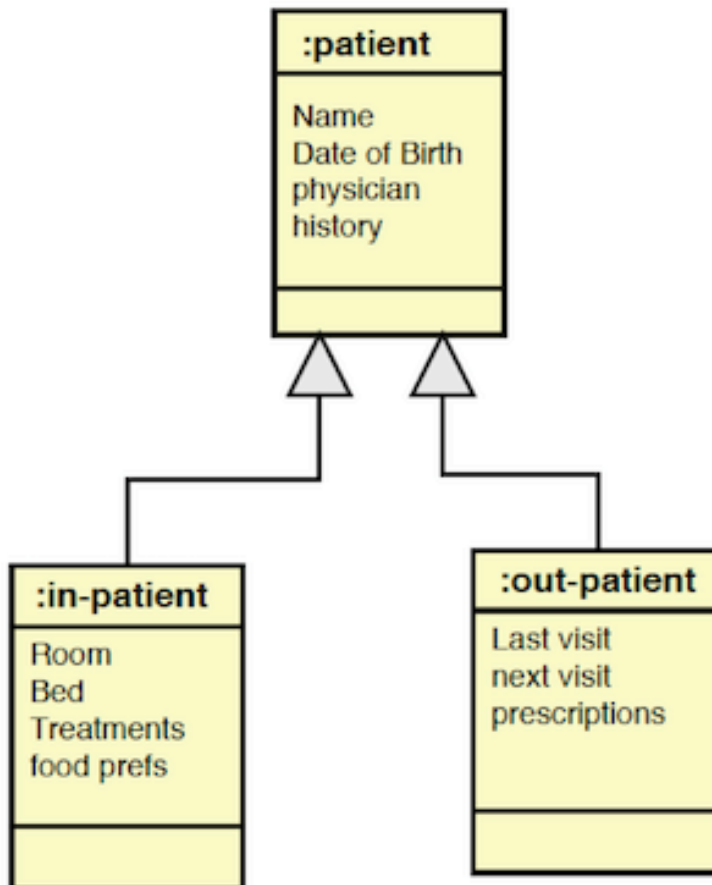

Aggregation (a partitioning hierarchy)

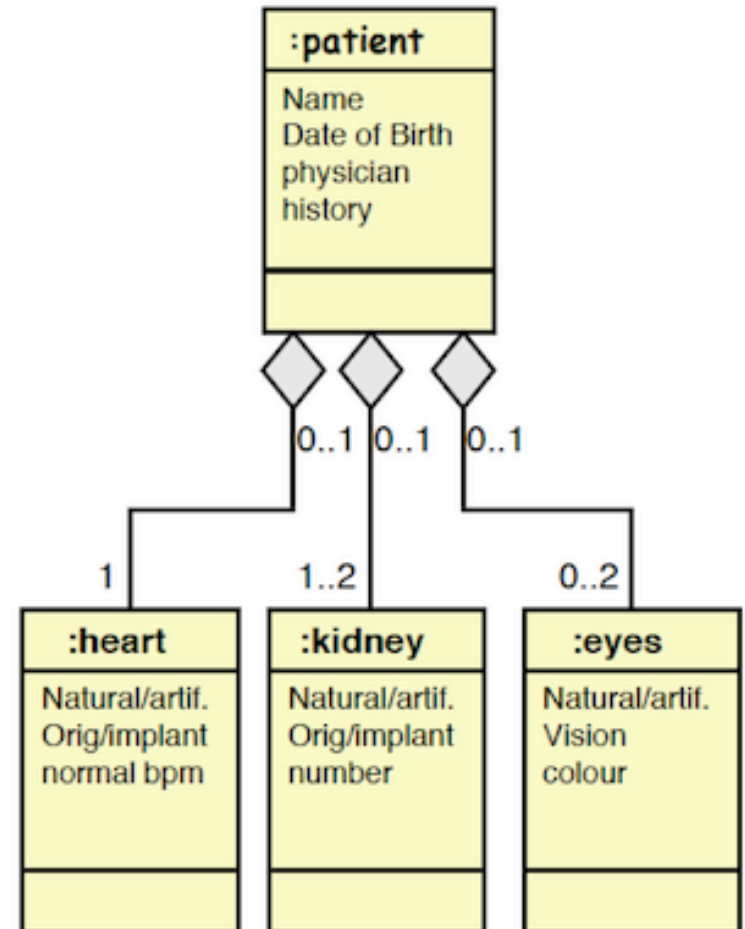



parts of a diagram

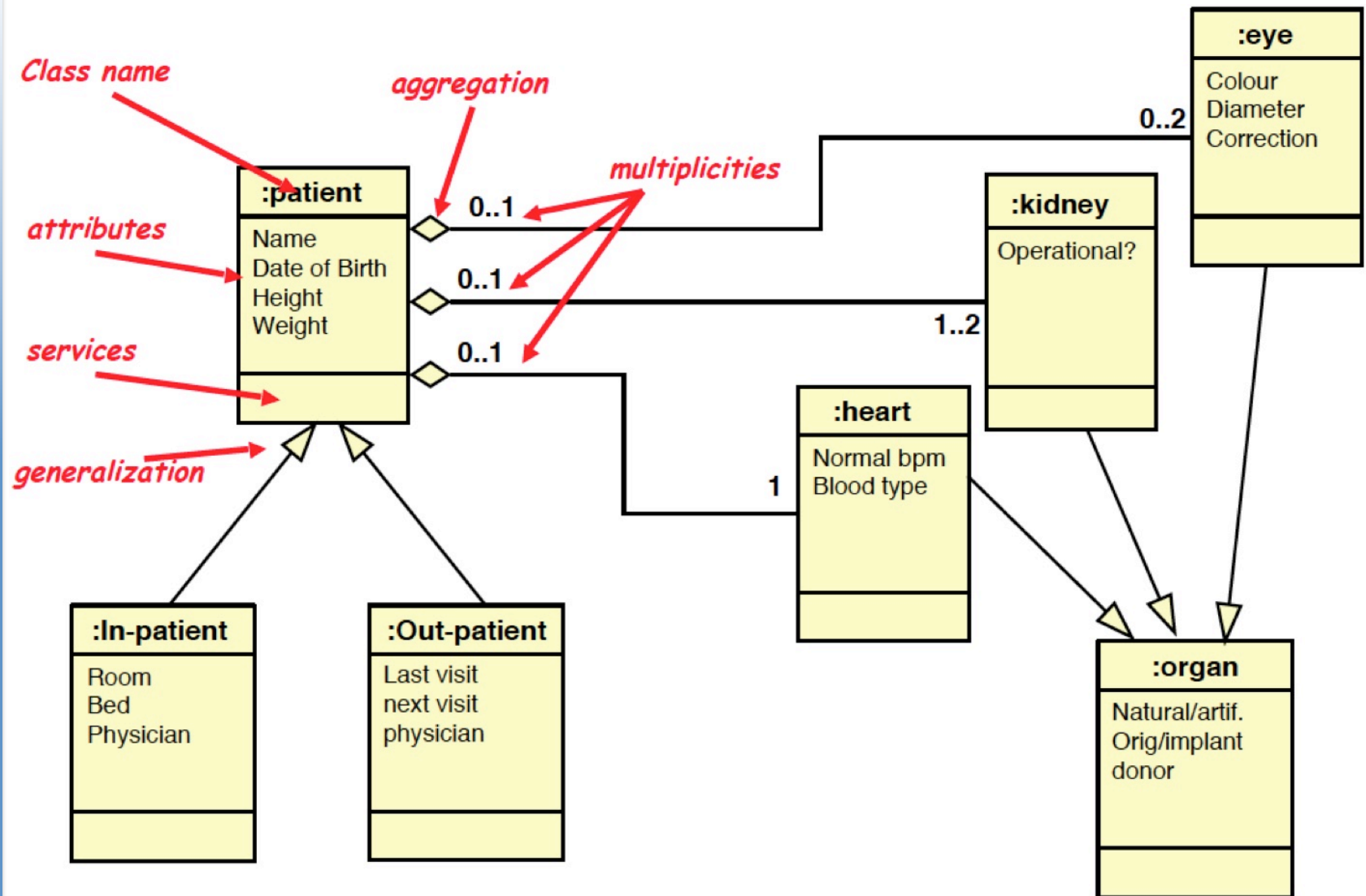



what are classes?

- a class describes a group of objects with
 - similar properties (attributes)
 - common behavior (operations)
 - common relation
 - and common meaning (semantics)
- example
 - employee: has a name, employee number and department; and employee is hired and fired (not very nice!); can work on one or more projects

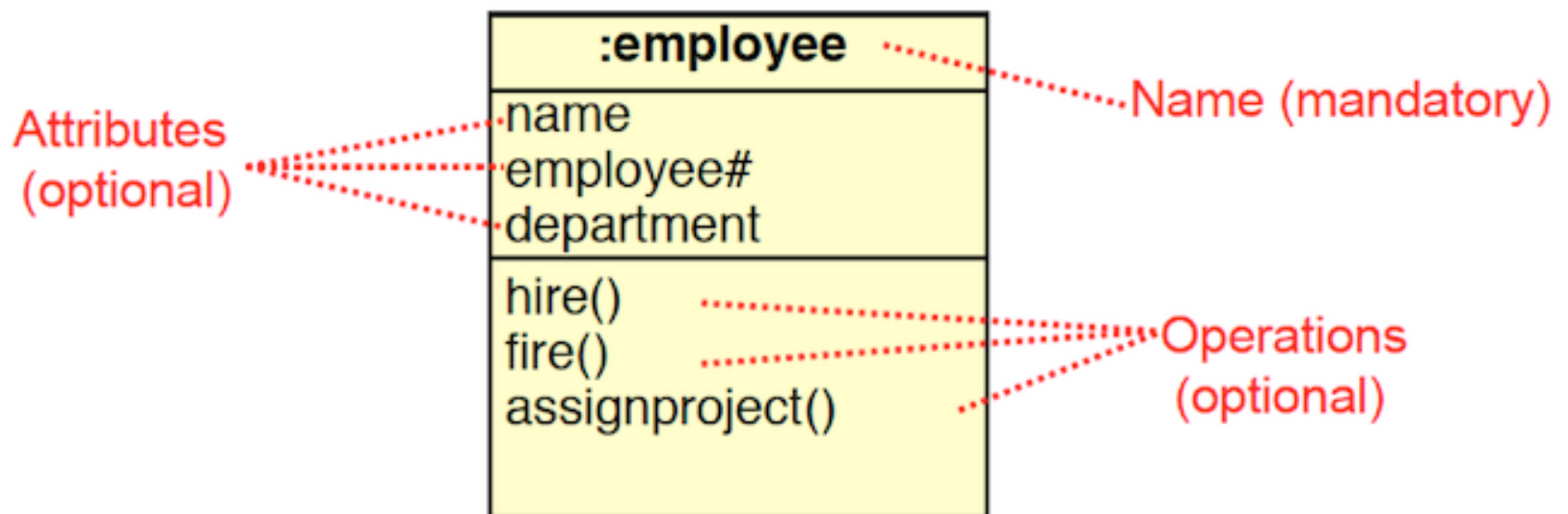



full class notation

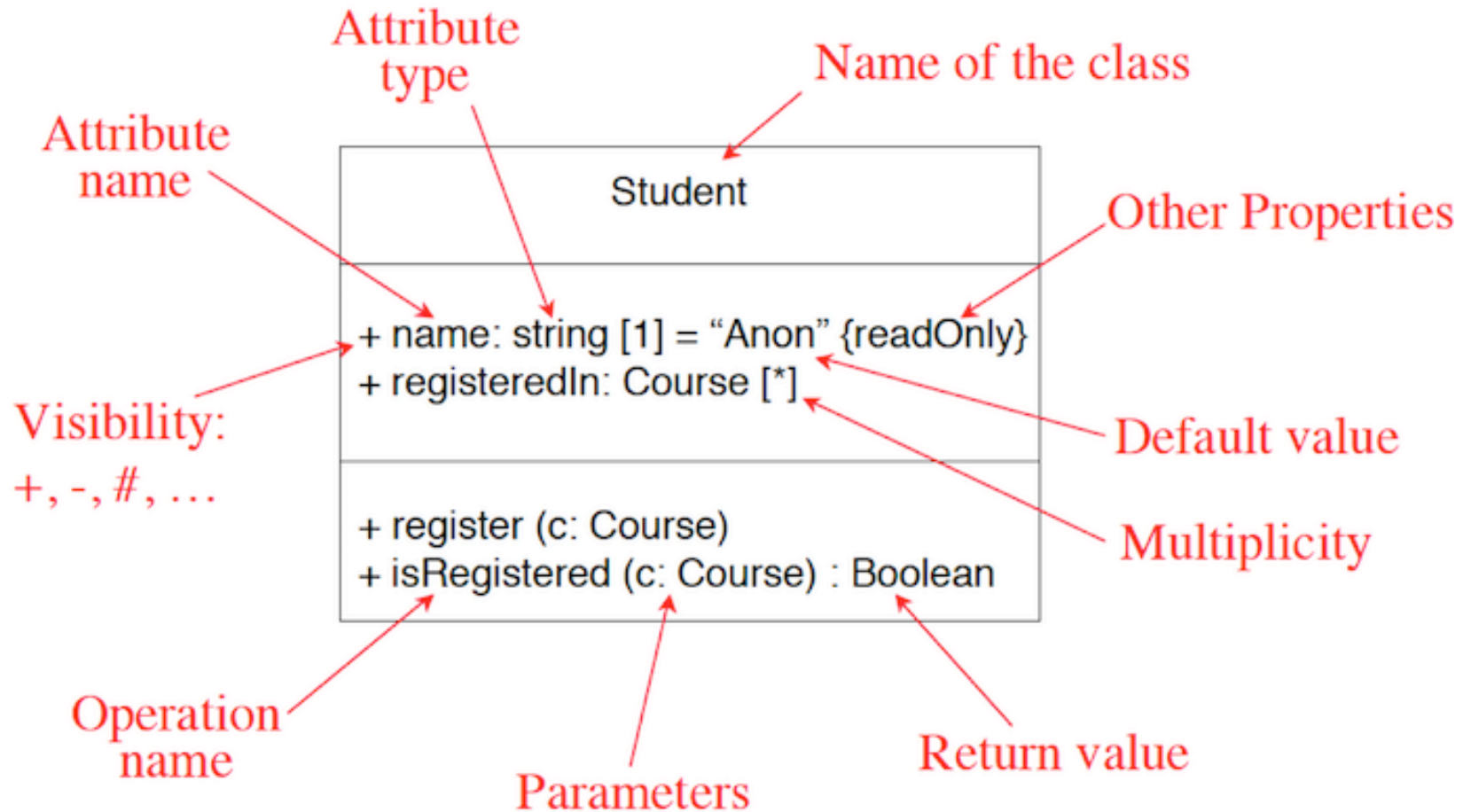



objects vs. classes

- instances of a class are called objects

- objects are represented as:

Fred_Bloggs:Employee
name: Fred Bloggs Employee #: 234609234 Department: Marketing

- two different objects may have identical attribute values (like two people with the same name and address)
- Objects have associations with other objects
 - ex. `Fred_Bloggs:employee` is associated with the `KillerApp:project` object
 - but we will capture these relationships at the class level (why?)
 - note: make sure attributes are associated with the right class
 - ex. don't want `managerName` and `employee#` as attributes of a project (why?)



generalization

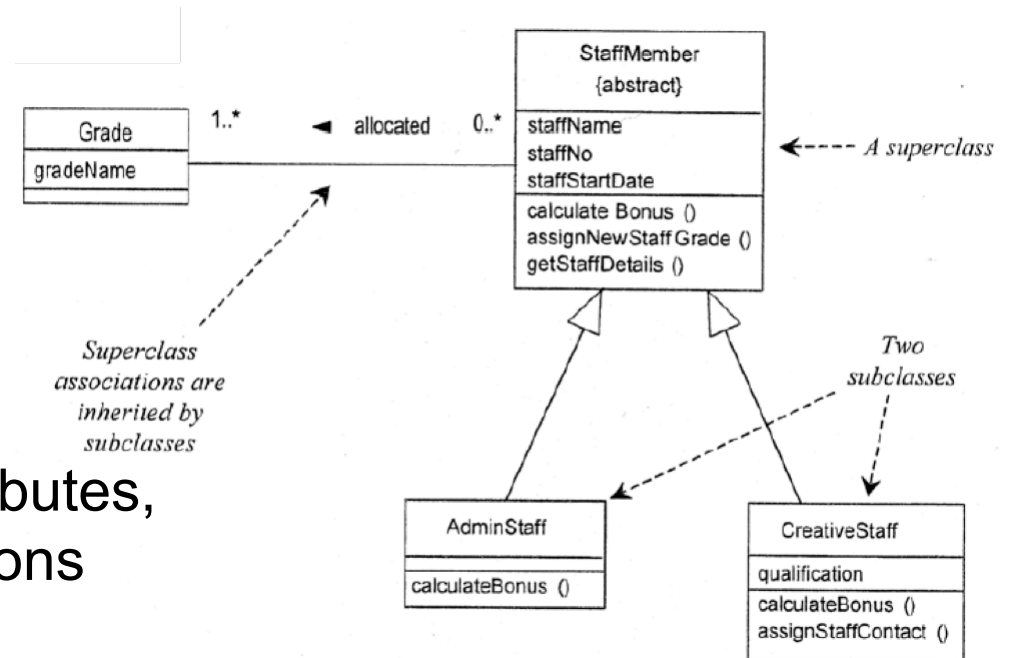

- subclasses inherit attributes, associations & operations from the superclass
- a subclass may override an inherited aspect
 - ex. `AdminStaff` & `CreativeStaff` have different methods for calculating bonuses
- superclasses may be declared `{abstract}`, meaning they have no instances
 - implies the subclasses cover all possibilities
 - ex. there are no other staff than `AdminStaff` and `CreativeStaff`



aggregation & composition

- aggregation
 - this is the “has-a” or whole/part relationship
- composition
 - strong form of aggregation that implies ownership
 - if the whole is removed from the model so is the part
 - the whole is responsible for the disposition of its parts

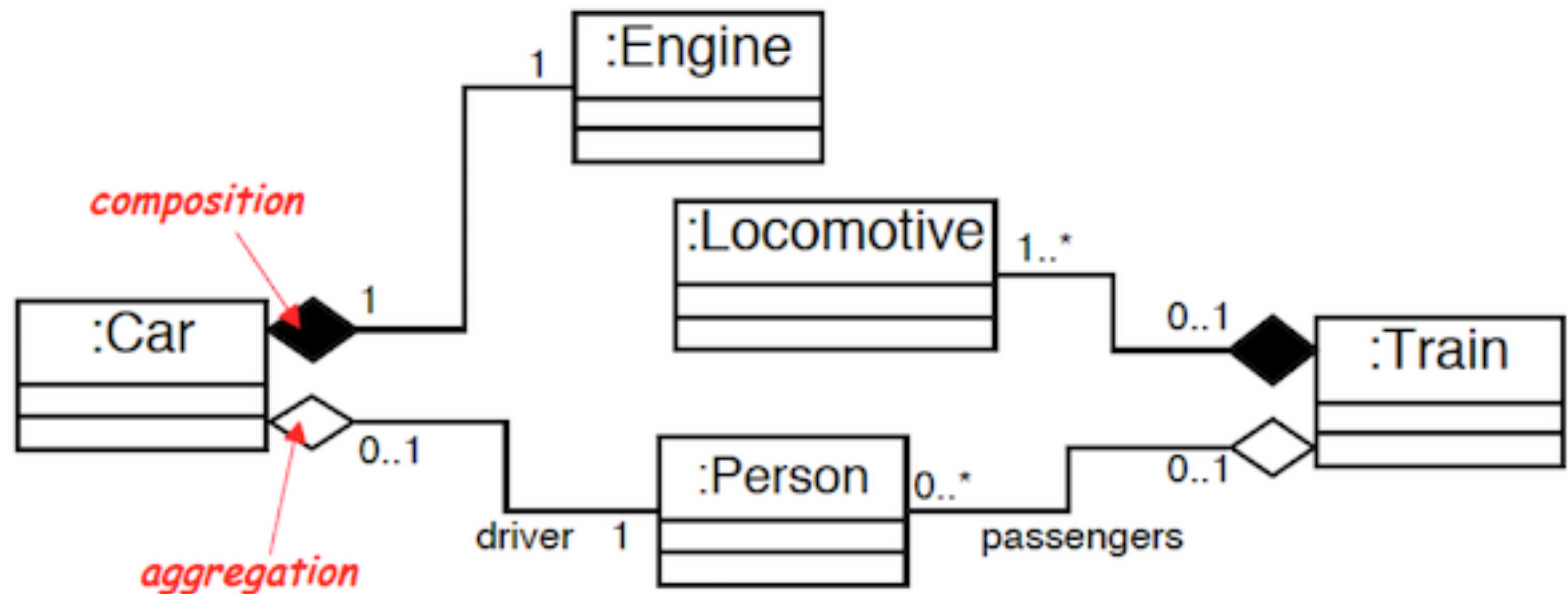



aggregation & composition (2)

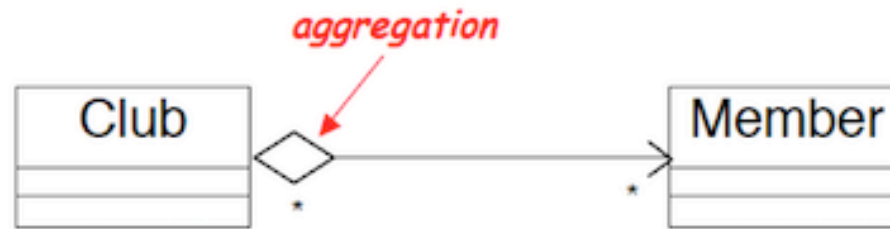

*What does
this mean??*

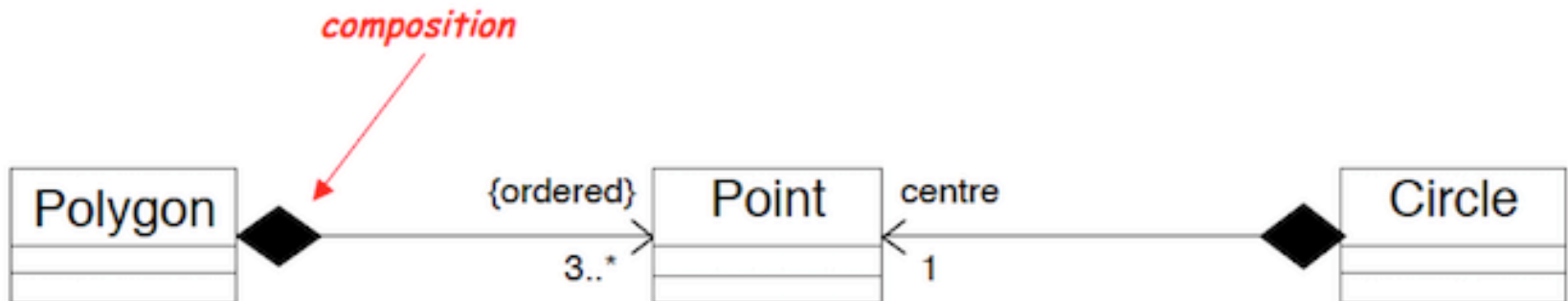

*Note: No sharing - any instance of point can
be part of a polygon or a circle, but not both*



associations

- objects do not exist in isolation from one another
 - a relationship represents a connection among things
 - in UML there are different types of relationships:
 - association, aggregation & composition, generalization, dependency, realization
- class diagrams show classes and their relationships

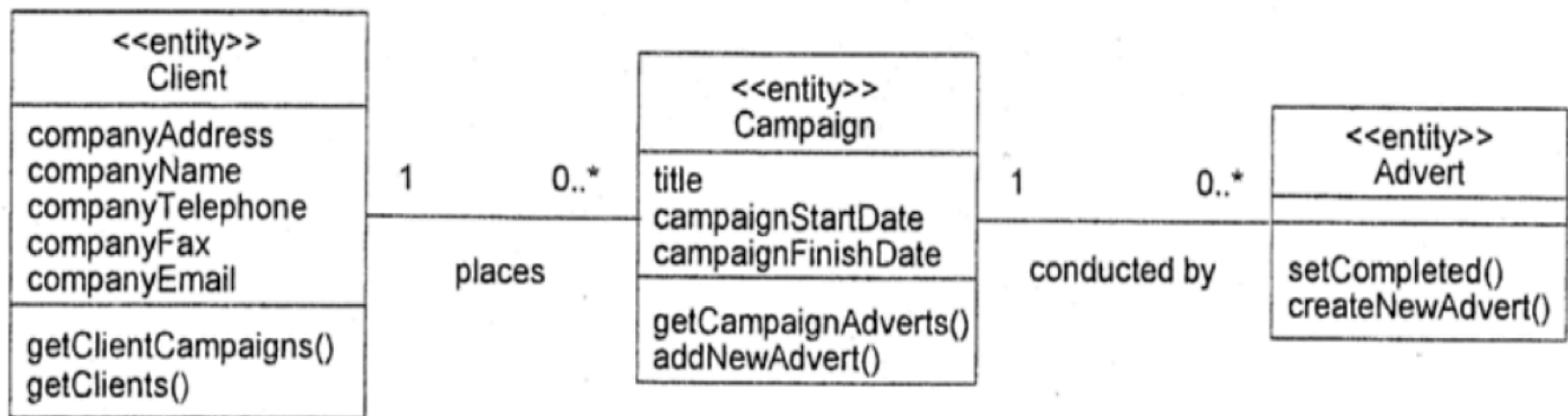



association multiplicity

- ask questions about the associations:
 - can a campaign exist without a member of staff to manage it?
 - if yes, the association is optional at the staff end – zero or more (0..*)
 - if no, then it is not optional – one or more (1..*)
 - if it must be managed by one, and only one, member of staff – exactly one (1)
 - what about the other end of the association?
 - does every member of staff have to manage exactly one campaign?
 - no, so the correct multiplicity is 0..*
- some examples:

optional	0..1	exactly one	1 (or 1..1)
zero or more	0..* (or just *)	one or more	1..*
range	2..6		



class associations

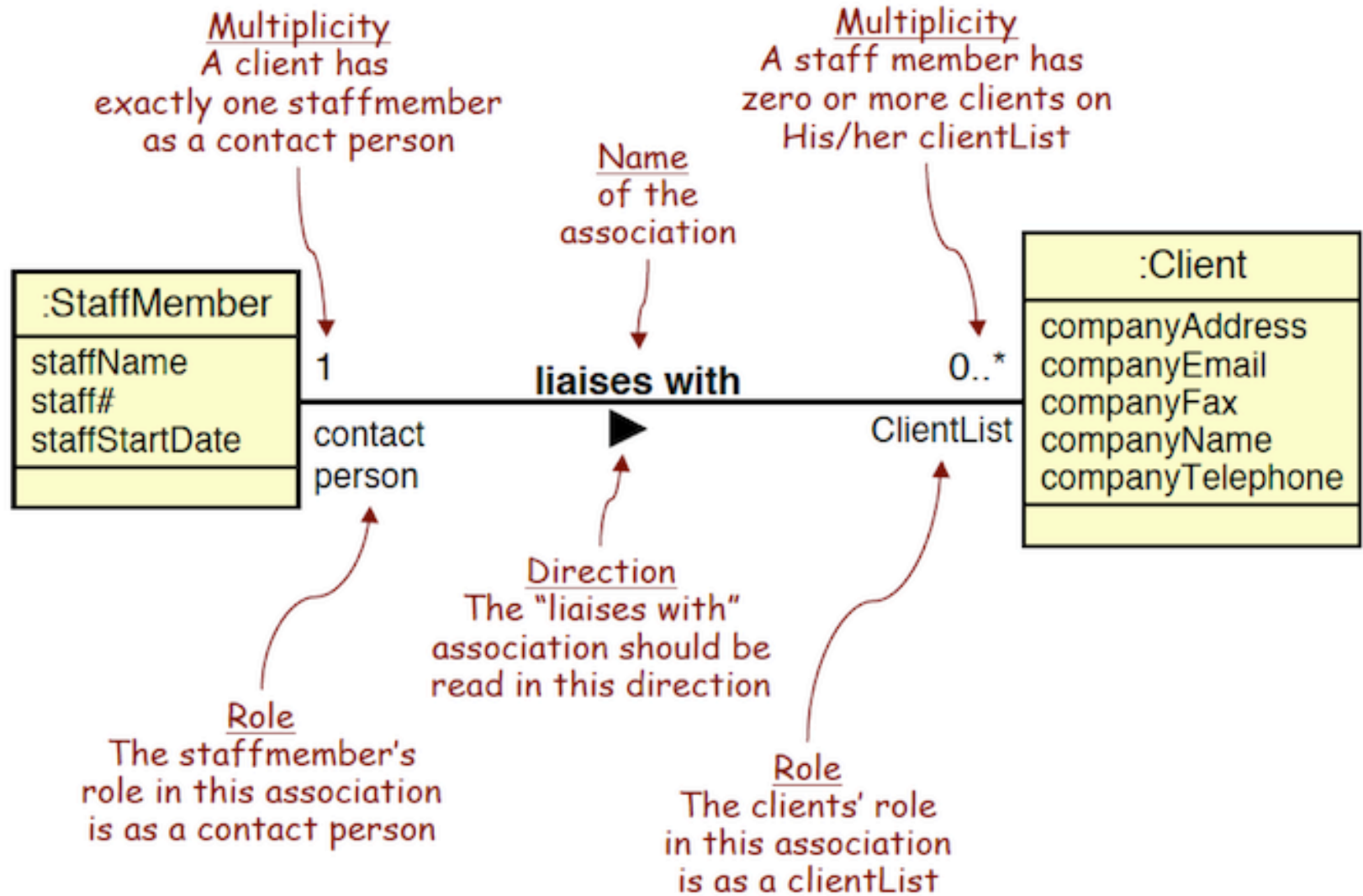



examples

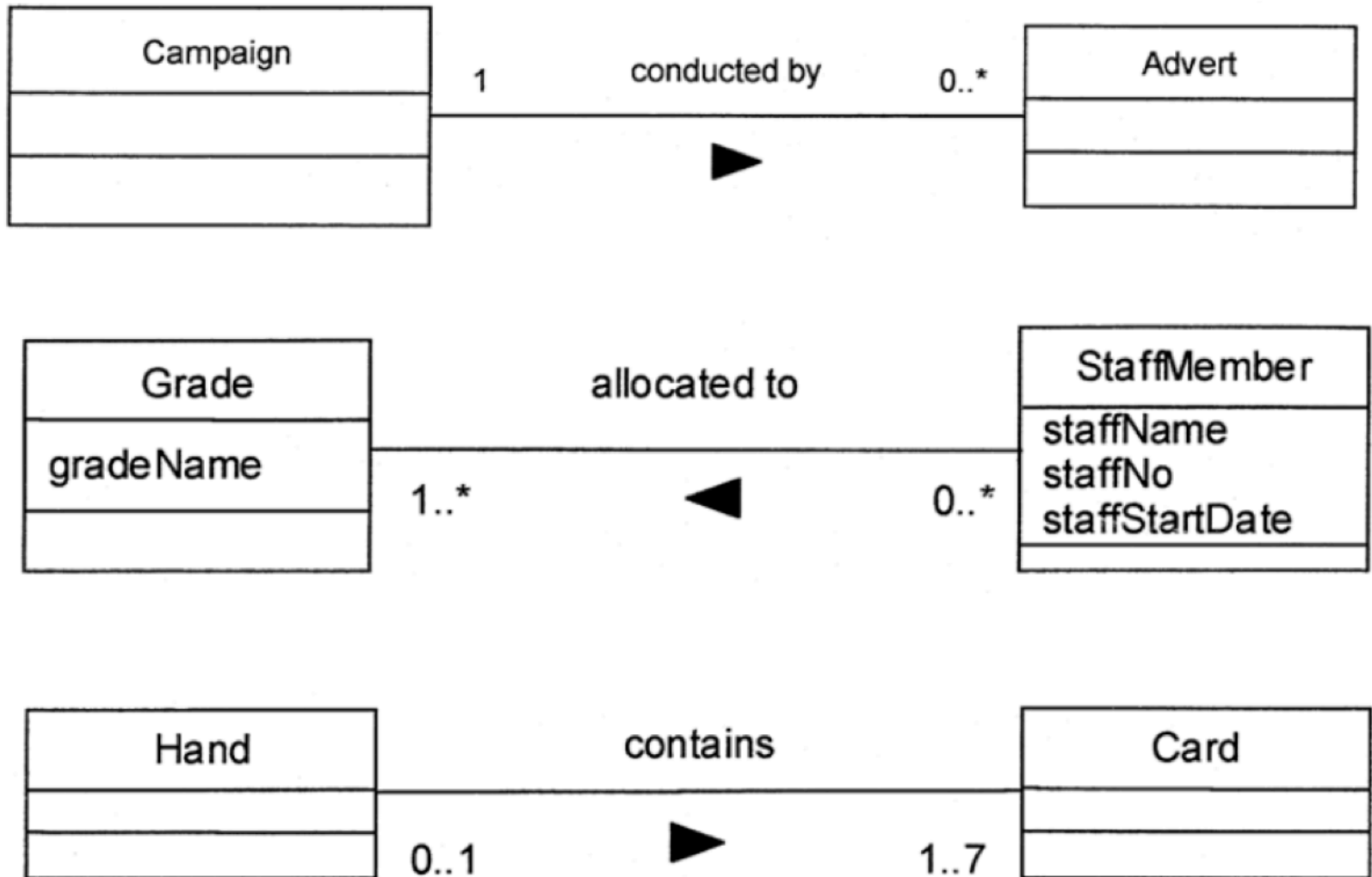



navigability / visibility

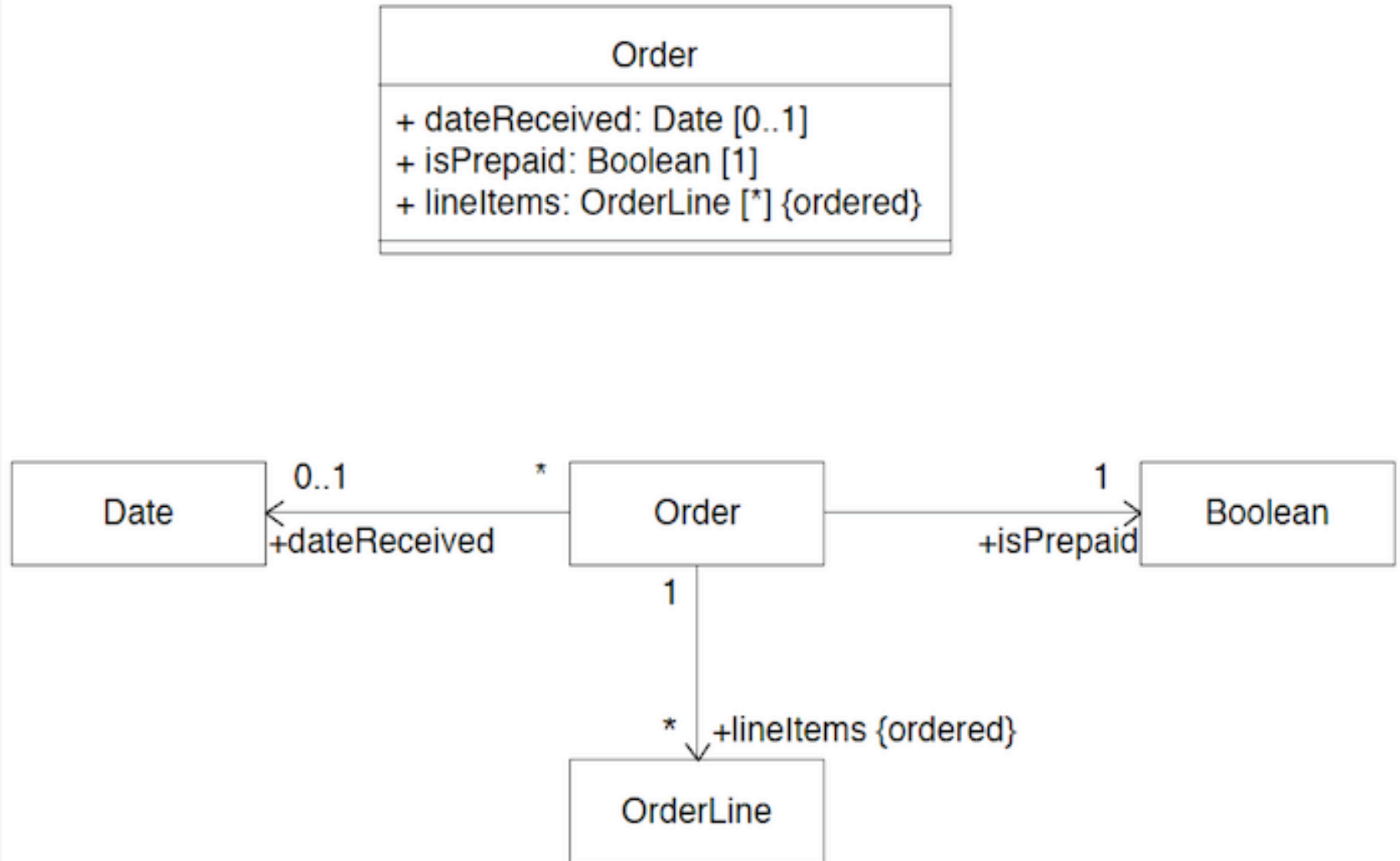



bidirectional associations

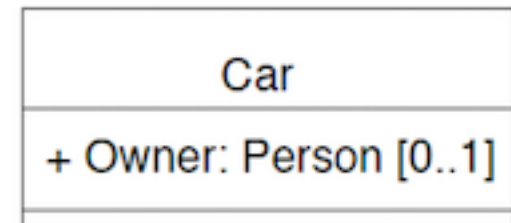
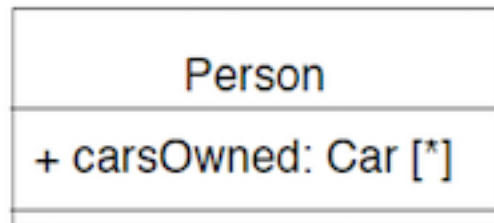

hard to implement correctly



dependencies

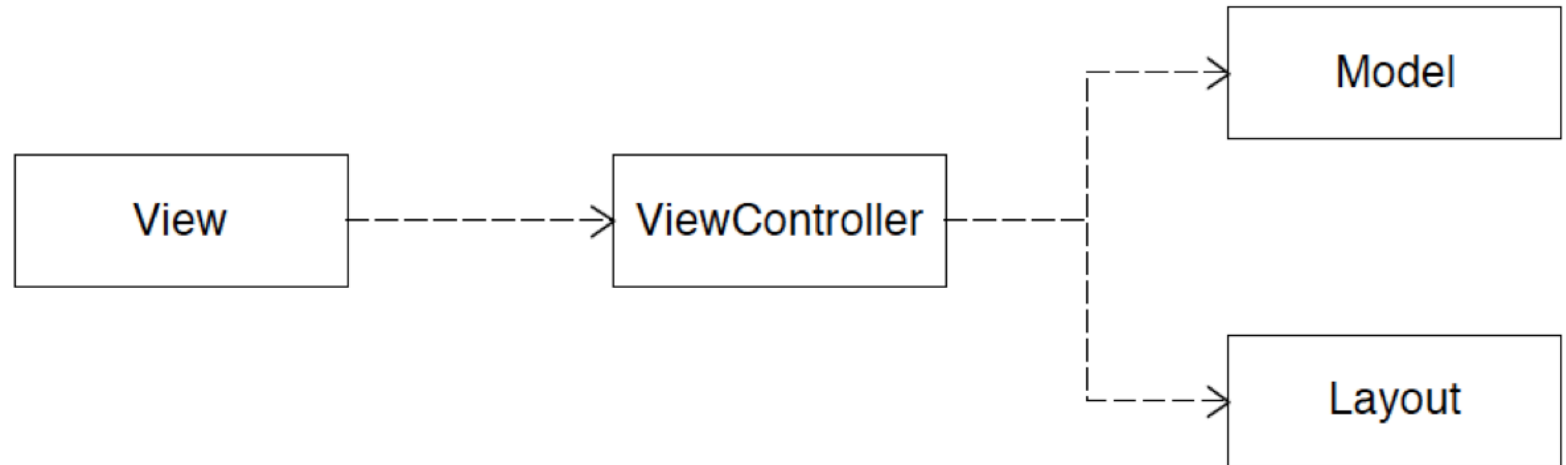

- Examples

`<<call>>`

`<<use>>`

`<<create>>`

`<<derive>>`

`<<instantiate>>`

`<<permit>>`

`<<realize>>`

`<<refine>>`

`<<substitute>>`

`<<parameter>>`



interfaces

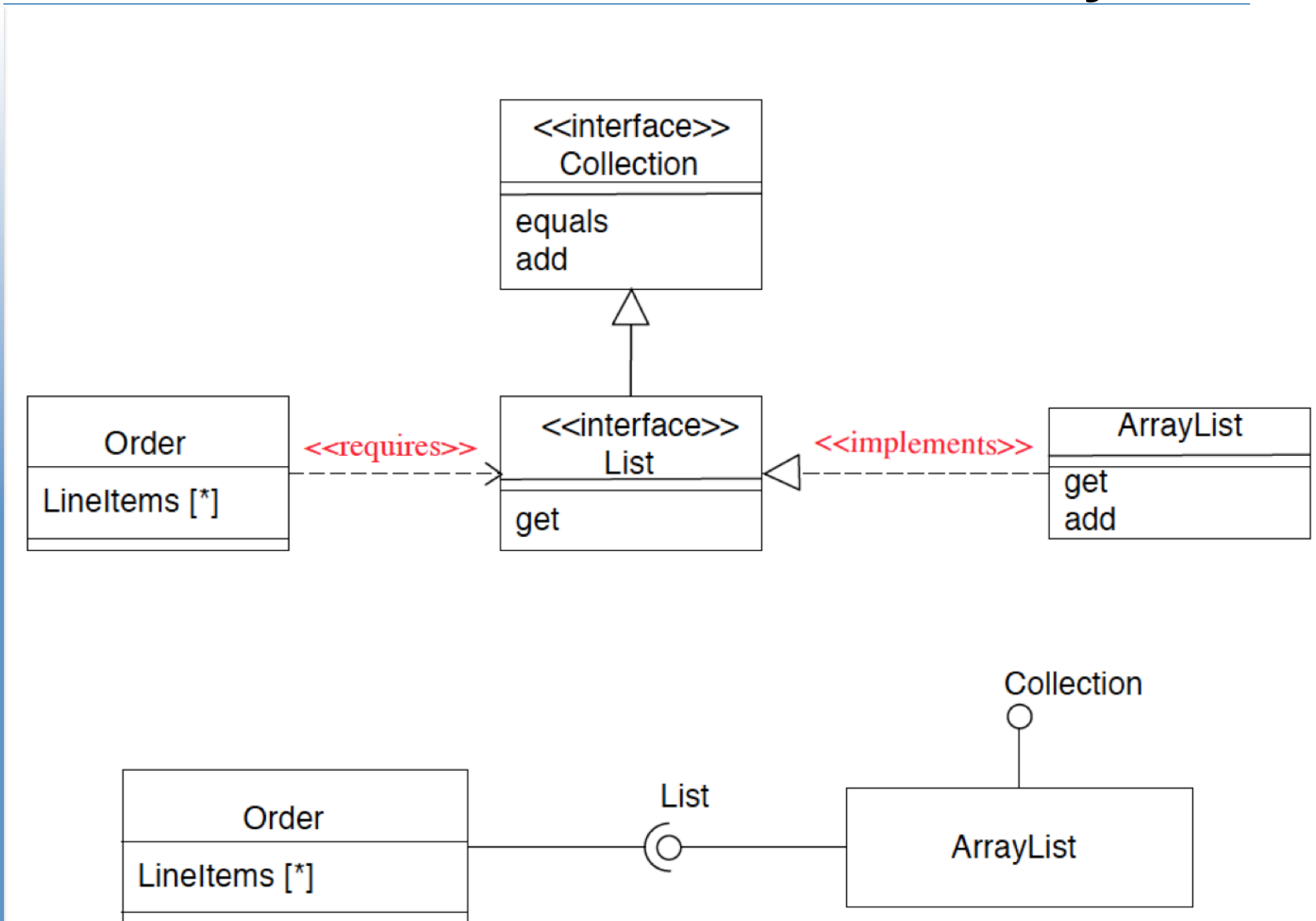



- **comments**
 - -- used to add comments within class description
- **notes**

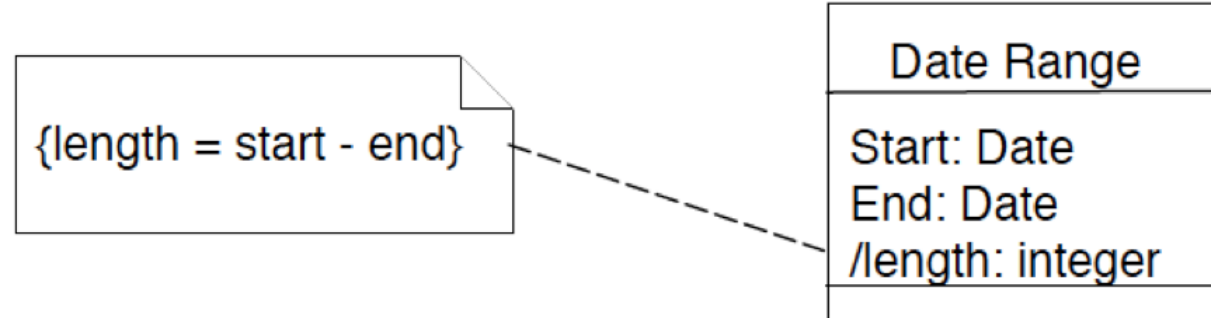

- **constraint rules**
 - any further constraints {in curly braces}
 - ex. {time limit: length must be less than 3 months}



what class diagrams can show

- division of responsibility
 - operations that objects are responsible for providing
- subclassing
 - inheritance, generalization
- navigability / visibility
 - when objects need to know about other objects to call their operations
- aggregation / composition
 - when objects are part of other objects
- dependencies
 - when changing the design of a class will affect other classes
- interfaces
 - used to reduce coupling between objects



static vs. dynamic modeling

- static captures fixed, code-level, relationships
 - class (and package) diagrams
 - object diagrams
 - component diagrams
 - deployment diagrams
- behavioral diagrams capture dynamic, execution time, relationships
 - use case diagrams
 - sequence and interaction diagrams
 - collaboration diagrams
 - statechart diagrams
 - activity diagrams



- **summary on modeling**
 - important to use modeling during design
 - modeling can be helpful to discover design and architecture (a1)
 - as with most things, it can be taken too far
 - the model should provide an easier to consume abstraction
 - strict uml is good when publishing designs for external consumption even if you don't use it yourself